



**100% PURE SINE WAVE HOME INVERTER**

# USER'S MANUAL

## SOLAR INVERTER

**PV3500 PRO 4KW~12KW**

Appliances



PC



TV



Air-  
conditioning



Fridge



Washing  
machine



# Table of Contents

<b>ABOUT THIS MANUAL</b> .....	1
Purpose .....	1
Scope .....	1
<b>SAFETY INSTRUCTIONS</b> .....	1
<b>INTRODUCTION</b> .....	2
Features.....	2
Basic System Architecture.....	2
Product Overview.....	3
<b>INSTALLATION</b> .....	4
Unpacking and Inspection.....	4
Preparation.....	4
Mounting the Unit.....	4
Battery Connection.....	5
AC Input/ Output Connection.....	6
Final Assembly.....	10
Communication Connection.....	10
<b>OPERATION</b> .....	10
Power ON/OFF.....	10
Operation and Display Panel.....	11
LCD Display Icons.....	12
LCD Setting.....	14
Fault Reference Code.....	19
Warning Indicator.....	21
Operating Mode Description.....	22
Display Setting.....	23
<b>SPECIFICATIONS</b> .....	23
Table 1 Line Mode Specifications.....	23
Table 2 Inverter Mode Specifications.....	24
Table 3 Charge Mode Specifications.....	25
Table 4 General Specifications.....	26
<b>TROUBLE SHOOTING</b> .....	27

## ABOUT THIS MANUAL

### Purpose

This manual describes the assembly, installation, operation and troubleshooting of this unit. Please read this manual carefully before installations and operations. Keep this manual for future reference.

### Scope

This manual provides safety and installation guidelines as well as information on tools and wiring.

### The following cases are not within the scope of warranty

1. Out of warranty.
2. Series number was changed or lost.
3. Battery capacity was declined or external damaged.
4. Inverter was damaged caused of transport shift, remissness, ect external factor
5. Inverter was damaged caused of irresistible natural disasters.
6. Not in accordance with the electrical power supply conditions or operate environment caused damage.

## SAFETY INSTRUCTIONS



**WARNING: This chapter contains important safety and operating instructions. Read and keep this manual for future reference.**

1. Before using the unit, read all instructions and cautionary markings on the unit the batteries and all appropriate sections of this manual.
2. **CAUTION** --To reduce risk of injury, charge only deep-cycle lead acid type rechargeable batteries. Other types of batteries may burst, causing personal injury and damage.
3. Do not disassemble the unit. Take it to a qualified service center when service or repair is required. Incorrect re-assembly may result in a risk of electric shock or fire.
4. To reduce risk of electric shock, disconnect all wirings before attempting any maintenance or cleaning. Turning off the unit will not reduce this risk.
5. **CAUTION** --Only qualified personnel can install this device with battery.
6. **NEVER** charge a frozen battery.
7. For optimum operation of this inverter/charger, please follow required spec to select appropriate cable size. It' s very important to correctly operate this inverter/charger.
8. Be very cautious when working with metal tools on or around batteries. A potential risk exists to drop a tool to spark or short circuit batteries or other electrical parts and could cause an explosion.
9. Please strictly follow installation procedure when you want to disconnect AC or DC terminals. Please refer to INSTALLATION section of this manual for the details.
10. GROUNDING INSTRUCTIONS- This inverter/charger should be connected to a permanent grounded wiring system. Be sure to comply with local requirements and regulation to install this inverter.
11. **NEVER** cause AC output and DC input short circuited. Do NOT connect to the mains when DC input short circuits.
12. **Warning!!** Only qualified service persons are able to service this device. If errors still persist after following troubleshooting table, please send this inverter/charger back to local dealer or service center for maintenance.

## INTRODUCTION

This is a multi-function inverter/charger, combining functions of inverter, solar charger and battery charger to offer uninterruptible power support with portable size. Its comprehensive LCD display offers user-configurable and easy-accessible button operation such as battery charging current, AC/solar charger priority, and acceptable input voltage based on different applications.

### Features

- Pure sine wave inverter
- Configurable input voltage range for home appliances and personal computers via LCD setting
- Configurable battery charging current based on applications via LCD setting
- Configurable AC/Solar Charger priority via LCD setting
- Compatible to mains voltage or generator power
- Auto restart while AC is recovering
- Overload/ Over temperature/ short circuit protection
- Smart battery charger design for optimized battery performance
- Cold start function

### Basic System Architecture

The following illustration shows basic application for this inverter/charger. It also includes following devices to have a complete running system:

Generator or Utility.

Battery

PV modules

Consult with your system integrator for other possible system architectures depending on your requirements.

This inverter can power all kinds of appliances in home or office environment, including motor-type appliances such as tube light, fan, refrigerator and air conditioner.

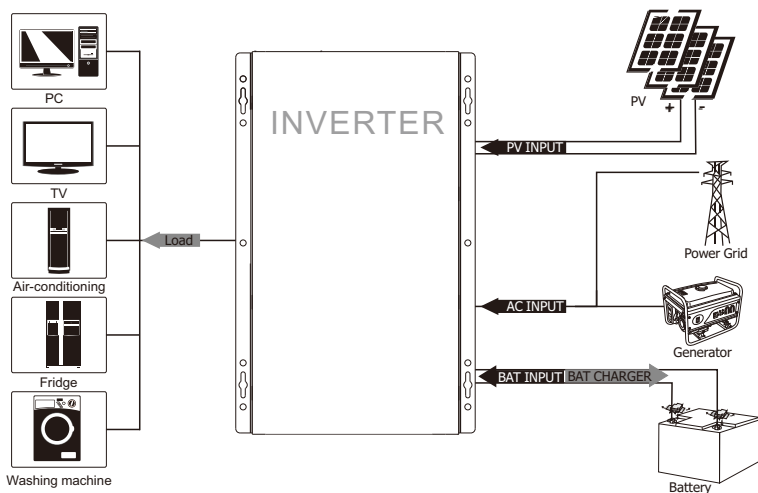
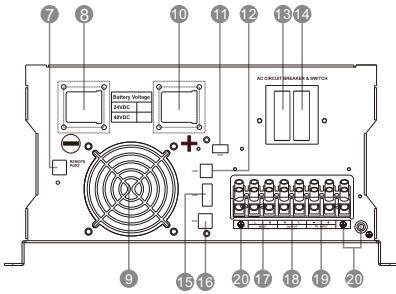
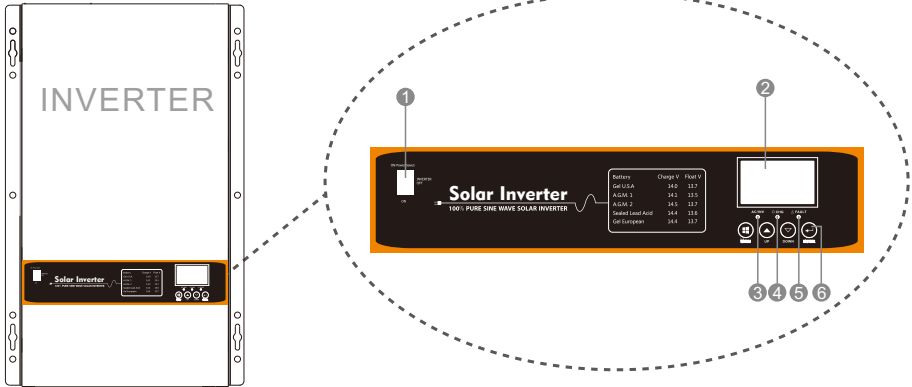

Figure 1 Hybrid Power System

## Product Overview



### 4KW-12KW single model

**NOTE:** For parallel model installation and operation, please check separate parallel installation guide for the details.

- 1.Power saver on/off switch
- 2.LCD display
- 3.Status indicator
- 4.Discharging/Charging indicator
- 5.Fault indicator
- 6.Function buttons
- 7.Remote control port
- 8.BAT -
- 9.FAN
- 10.BAT +
- 11.WI-FI port
- 12.USB communication port
- 13.AC input /bypass breaker
- 14.AC output breaker
- 15.AGS(Auto Generator Start)
- 16.BTS
- 17.AC input
- 18.AC output
- 19.PV input
- 20.Ground

## INSTALLATION

### Unpacking and Inspection

Before installation, please inspect the unit. Be sure that nothing inside the package is damaged. You should have received the following items inside of package:

- The unit x 1
- User manual x 1
- USB cable x 1
- Software CD x 1
- BTS Line x 1(Option)
- WIFI Key x 1(Option)
- Remote Line x 1(Option)

### Preparation

Before connecting all wirings, please take off bottom cover by removing six screws as shown below.

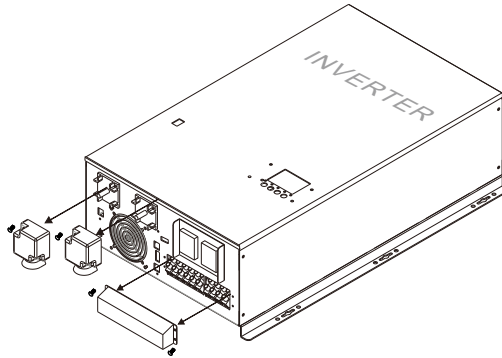

### Mounting the Unit

Consider the following points before selecting where to install:

- Do not mount the inverter on flammable construction materials.
- Mount on a solid surface.
- Install this inverter at eye level in order to allow the LCD display to be read at all times.
- For proper air circulation to dissipate heat, allow a clearance of approx. 50cm to the side and 80 cm above and below the unit.
- The ambient temperature should be between 0°C and 40°C to ensure optimal operation.
- The recommended installation position is to be adhered to the wall vertically.
- Be sure to keep other objects and surfaces as shown in the diagram to guarantee sufficient heat dissipation and to have enough space for removing wires

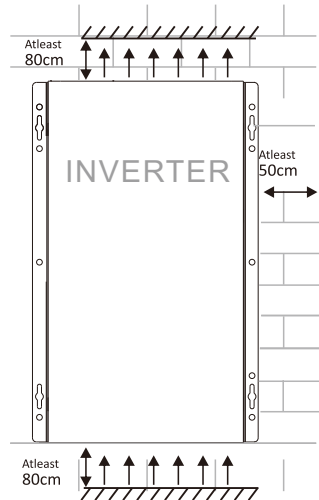

**SUITABLE FOR MOUNTING ON CONCRETE OR OTHER NON-COMBUSTIBLE SURFACE ONLY.**

Install the unit by screwing six screws

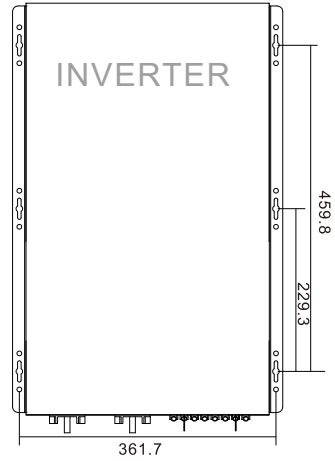
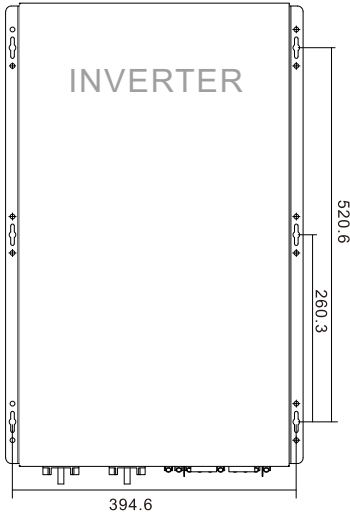

### Battery Connection

**CAUTION:** For safety operation and regulation compliance, it's requested to install a separate DC over-current protector or disconnect device between battery and inverter. It may not be requested to have a disconnect device in some applications, however, it's still requested to have over-current protection installed. Please refer to typical amperage in below table as required fuse or breaker size.

**WARNING!** All wiring must be performed by a qualified personnel.

**WARNING!** It's very important for system safety and efficient operation to use appropriate cable for battery connection. To reduce risk of injury, please use the proper recommended cable and terminal size as below.

### Ring terminal:

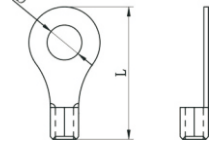

### Recommended battery cable and terminal size:

Model	Typical Amperage	Battery Capacity	Wire Size	Torque Value
4024	200A	400AH	2*2AWG	2~ 3 Nm
5024	250A	600AH	2*1AWG	2~ 3 Nm
4048	100A	400AH	1*2AWG	2~ 3 Nm
5048	130A	600AH	1*1AWG	2~ 3 Nm
6048	150A	800AH	2*3AWG	2~ 3 Nm
8048	200A	1000AH	2*2AWG	2~ 3 Nm
10048	250A	1200AH	2*1AWG	2~ 3 Nm
12048	300A	1400AH	3*2AWG	2~ 3 Nm

Please follow below steps to implement battery connection:

1. Assemble battery ring terminal based on recommended battery cable and terminal size.



**NOTE:** Please only use sealed lead acid battery or sealed GEL/AGM lead-acid battery.

3. Insert the ring terminal of battery cable flatly into battery connector of inverter and make sure the bolts are tightened with torque of 2-3 Nm. Make sure polarity at both the battery and the inverter/charge is correctly connected and ring terminals are tightly screwed to the battery terminals.

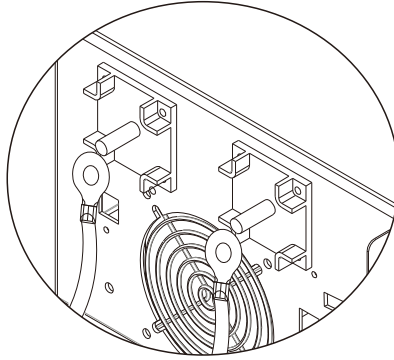

**WARNING: Shock Hazard**

Installation must be performed with care due to high battery voltage in series.



**CAUTION!!** Do not place anything between the flat part of the inverter terminal and the ring terminal. Otherwise, overheating may occur.

**CAUTION!!** Do not apply anti-oxidant substance on the terminals before terminals are connected tightly.

**CAUTION!!** Before making the final DC connection or closing DC breaker/disconnector, be sure positive (+) must be connected to positive (+) and negative (-) must be connected to negative (-).

**AC Input/Output Connection**

**CAUTION!!** Before connecting to AC input power source, please install a separate AC breaker between inverter and AC input power source. This will ensure the inverter can be securely disconnected during maintenance and fully protected from over current of AC input. The recommended appropriate of AC breaker is 40A for 4KW-6KW, 80A for 8KW-12KW.

**CAUTION!!** Please don't connect the output wiring to "INPUT" terminal or connect the grid wiring to the "OUTPUT" terminal.

**WARNING!** All wiring must be performed by a qualified personnel.

**WARNING!** It's very important for system safety and efficient operation to use appropriate cable for AC input connection. To reduce risk of injury, please use the proper recommended cable size as below.

**Suggested cable requirement for AC wires**

Model	Gauge	Torque Value
4KW-5KW	10 AWG	1.4~ 1.6Nm
6KW-8KW	8 AWG	1.4~ 1.6Nm
10KW-12KW	2*10 AWG	1.6~ 1.8Nm

Please follow below steps to implement AC input/output connection:

1. Before making AC input/output connection, be sure to open DC protector or disconnecter first.
2. Remove insulation sleeve 10mm for six conductors. And shorten phase L and neutral conductor N 3mm.
3. Insert AC input wires according to polarities indicated on terminal block and tighten the terminal screws. Be sure to connect PE protective conductor (⊕) first.

- ⊕ → **Ground (yellow-green)**
- L → **LINE (brown or black)**
- N → **Neutral (blue)**

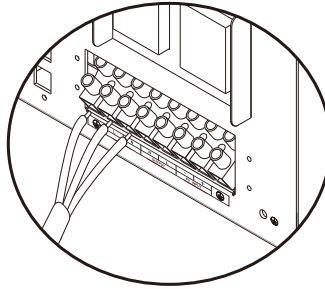

**WARNING:**

Be sure to that AC power source is disconnected before attempting to hardwire it to the unit.

4. Then, insert AC output wires according to polarities indicated on terminal block and tighten terminal screws. Be sure to connect PE protective conductor (⊕) first.

- ⊕ → **Ground (yellow-green)**
- L → **LINE (brown or black)**
- N → **Neutral (blue)**

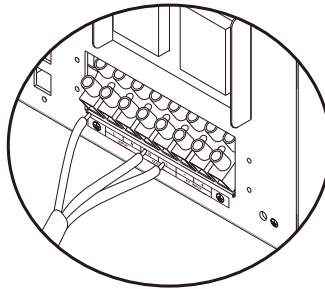

5. Make sure the wires are securely connected.

**CAUTION:** Important

Be sure to connect AC wires with correct polarity. If L and N wires are connected reversely, it may cause utility short-circuited when these inverters are worked in parallel operation.

**CAUTION:** Appliances such as air conditioner are required at least 2~3 minutes to restart because it's required to have enough time to balance refrigerant gas inside of circuits. If a power shortage occurs and recovers in a short time, it will cause damage to your connected appliances. To prevent this kind of damage, please check manufacturer of air conditioner if it's equipped with time-delay function before installation. Otherwise, this inverter/charger will trig overload fault and cut off output to protect your appliance but sometimes it still causes internal damage to the air conditioner.

**PV Connection**

**CAUTION:** Before connecting to PV modules, please install separately a DC circuit breaker between inverter and PV modules.

**WARNING!** All wiring must be performed by a qualified personnel.

**WARNING!** It's very important for system safety and efficient operation to use appropriate cable for PV module connection. To reduce risk of injury, please use the proper recommended cable size as below.

Model	Typical Amperage	Cable Size	Torque
4024-80A 5024-80A	80A	8AWG	1.6~1.8 Nm
4048-80A 5048-80A 6048-80A	80A	8AWG	1.6~1.8 Nm
8048-100A/200A 10048-100A/200A 12048-100A/200A	100A/200A	6AWG/2*6AWG	1.8~2.0 Nm

**PV Module Selection:**

When selecting proper PV modules, please be sure to consider below parameters:

1. Open circuit Voltage (Voc) of PV modules not exceeds max. PV array open circuit voltage of inverter.
2. Open circuit Voltage (Voc) of PV modules should be higher than min. battery voltage.

Solar Charging Mode		
INVERTER MODEL	24V	48V
Max. PV Array Open Circuit Voltage	145Vdc	
PV Array MPPT Voltage Range	30~130Vdc	60~130Vdc
Min. battery voltage for PV charge	Battery voltage +3Vdc	

Please follow below steps to implement PV module connection:

1. Remove insulation sleeve 10 mm for positive and negative conductors
2. Check correct polarity of connection cable from PV modules and PV input connectors. Then, connect positive pole (+) of connection cable to positive pole (+) of PV input connector. Connect negative pole (-) of connection cable to negative pole (-) of PV input connector.

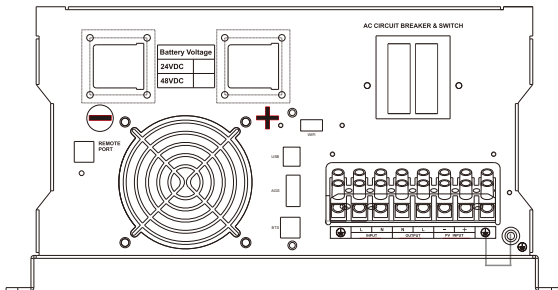
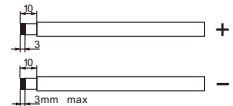

3. Make sure the wires are securely connected.

## PV Wiring

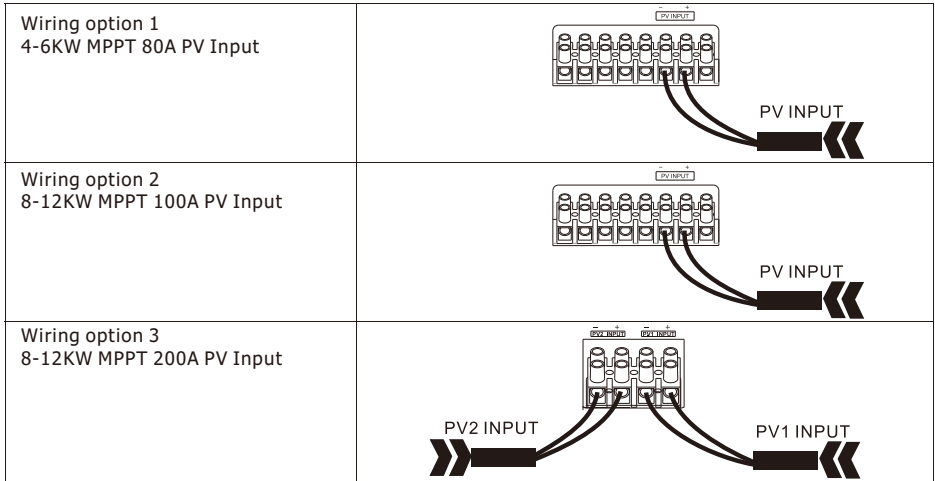

## Recommended PV module configuration

PV Module Spec.(reference)	Inverter Model	Solar Input	Q'ty of modules
-260W -Vmp:30.9Vdc -Imp:8.42A -Voc:37.7Vdc -Isc:8.89A -Cells:60	24V/80A	3S3P	9PCS
	48V/80A	3S6P	18PCS

## Solar panel installation schematic

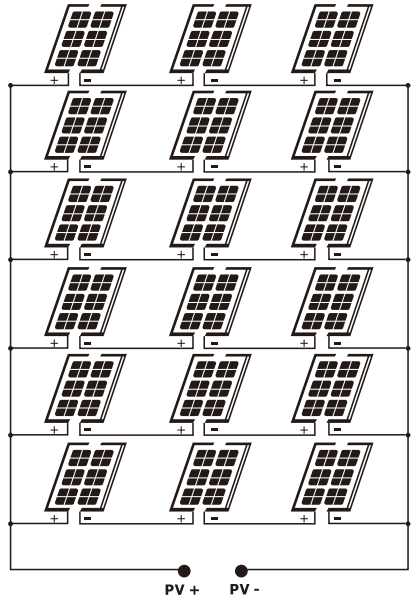
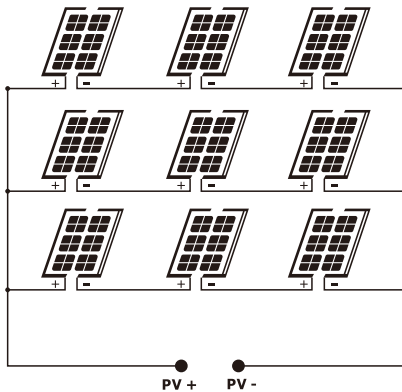

## Final Assembly

After connecting all wirings, please put bottom cover back by screwing two screws as shown below.

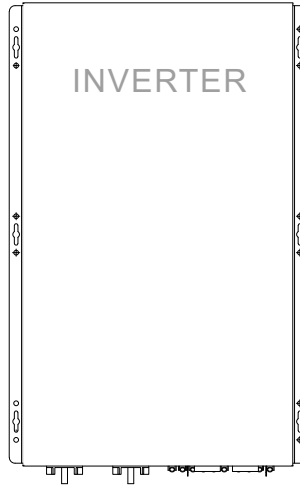

## Communication Connection

Please use supplied communication cable to connect to inverter and PC. Insert bundled CD into a computer and follow on-screen instruction to install the monitoring software. For the detailed software operation, please check user manual of software inside of CD.

## OPERATION

Power ON/OFF/Power Saver

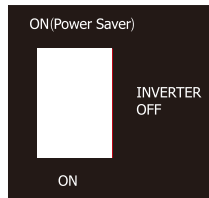

There are 3 different status for inverter: "ON(Power Saver)", "INVERTER OFF" and "ON"

When power switch is in "INVERTER OFF" position, the inverter is powered off.

When power switch is turned to either of "ON(Power Saver)" or "ON", the inverter is powered on.

Power saver function is designed to conserve battery power when AC power is not or rarely required by the loads. In this mode, the inverter pulses the AC load. Whenever an AC load (greater than 80 watts) is turned on, the inverter recognizes the need for power and automatically starts inverting and output goes to full voltage. When there is no load (or less than 30 watts) detected, the inverter automatically goes back into search mode to minimize energy consumption from the battery bank. In "ON(Power Saver)" mode, the inverter will draw power mainly in sensing moments, thus the idle consumption is significantly reduced.

## Remote control

Apart from the switch panel on the front of the inverter, an switch panel connected to the RJ 11 port at the DC side of the inverter thru a standard telephone cable can also control the operation of the inverter. If an extra switch panel is connected to the inverter via "remote control port" together with the panel on the inverter case, the two panels will be connected and operated in parallel.

Whichever first switches from "OFF" to "Power saver off" or "Power saver on" it will power the inverter on. If the commands from the two panels conflict, the inverter will accept command according to the following priority: Power saver on/Power saver off/Power off, Only when both panels are turned to "Unit Off" position will the inverter be powered off.

The Max length of the cable is 10 meters.



### WARNING!

Never cut the telephone cable when the cable is attached to inverter and battery is connected to the inverter. Even if the inverter is turned off. It will damage the remote PCB inside if the cable is short circuited during cutting.

## Auto generator start (AGS)

There is an extra connector in front of the inverter used to start the generator. If the utility power is abnormal and single battery discharges below setting point in program 19, the inverter will send out a signal to the cable of the connector which is cascaded to the control circuit of the generator, owing to this the control circuit will get through and then generator will be started. if single battery is charged higher than 13.5Vdc, the signal will disappear to make the generator keeping closed again.

## Operation and Display Panel

The operation and display panel, shown in below chart, is on the front panel of the inverter. It includes three indicators, four function keys and a LCD display, indicating the operating status and input/output power information.

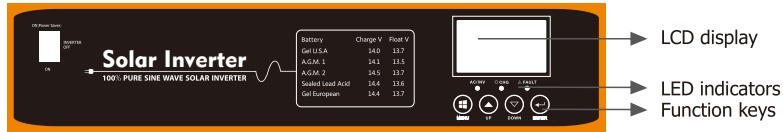

## LED Indicator

LED Indicator		Messages	
AC/INV	Green	Solid On	Output is powered by grid in Line mode.
		Flashing	Output is powered by battery or PV in battery mode.
CHG	Yellow	Flashing	Battery is charging or discharging.
FAULT	Red	Solid On	Fault occurs in the inverter.
		Flashing	Warning condition occurs in the inverter.







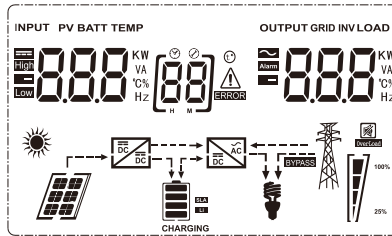





## Function Keys

Function Keys	Description.
MENU	Enter or exit setting mode or go to previous selection.
UP	Increase the setting data.
DOWN	Decrease the setting data.
ENTER	Enter setting mode and Confirm the selection in setting mode go to next selection.







## LCD Display Icons







Icon	Function description														
<b>Input Source Information and Output Information</b>															
	Indicates the AC information														
	Indicates the DC information														
	Indicate input voltage, input frequency, PV voltage, battery voltage and charger current. Indicate output voltage, output frequency, load in VA, load in Watt and discharging current.														
<b>Configuration Program and Fault Information</b>															
	Indicates the setting programs														
	Indicates the warning and fault codes. Warning:  flashing with warning code. Fault:  lighting with fault code.														
<b>Battery Information</b>															
	Indicates battery level by 0-24%, 25-49%, 50-74% and 75-100% in battery mode and charging status in line mode.														
In AC mode, it will present battery charging status.															
<table border="1"> <thead> <tr> <th>Status</th> <th>Battery voltage</th> <th>LCD Display</th> </tr> </thead> <tbody> <tr> <td rowspan="4">Constant Current mode/Constant Voltage mode</td> <td>&lt;2V/cell</td> <td>4 bars will flash in turns</td> </tr> <tr> <td>2v/cell~2.083v/cell</td> <td>Bottom bar will be on and the other three bars will flash in turns.</td> </tr> <tr> <td>2.083v/cell~2.167v/cell</td> <td>Bottom two bars will be on and the other two bars will flash in turns.</td> </tr> <tr> <td>&gt;2.167V/cell</td> <td>Bottom three bars will be on and the top bar will flash.</td> </tr> <tr> <td colspan="2">Batteries are fully charged.</td> <td>4 bars will be on.</td> </tr> </tbody> </table>	Status	Battery voltage	LCD Display	Constant Current mode/Constant Voltage mode	<2V/cell	4 bars will flash in turns	2v/cell~2.083v/cell	Bottom bar will be on and the other three bars will flash in turns.	2.083v/cell~2.167v/cell	Bottom two bars will be on and the other two bars will flash in turns.	>2.167V/cell	Bottom three bars will be on and the top bar will flash.	Batteries are fully charged.		4 bars will be on.
Status	Battery voltage	LCD Display													
Constant Current mode/Constant Voltage mode	<2V/cell	4 bars will flash in turns													
	2v/cell~2.083v/cell	Bottom bar will be on and the other three bars will flash in turns.													
	2.083v/cell~2.167v/cell	Bottom two bars will be on and the other two bars will flash in turns.													
	>2.167V/cell	Bottom three bars will be on and the top bar will flash.													
Batteries are fully charged.		4 bars will be on.													

In battery mode, it will present battery capacity.		
Load Percentage	Battery Voltage	LCD Display
Load >50%	<1.717V/cell	
	1.717V/cell~1.8V/cell	
	1.8V/cell~1.883V/cell	
	>1.883 V/cell	
50%> Load>20%	<1.817V/cell	
	1.817V/cell~1.9V/cell	
	1.9 V/cell ~1.983V/cell	
	>1.983 V/cell	
Load<20%	<1.867V/cell	
	1.867V/cell~1.95V/cell	
	1.95V/cell~2.033V/cell	
	>2.033 V/cell	

### Load Information

	Indicates overload.			
	Indicates the load level by 0-24%, 25-49%, 50-74% and 75-100%.			
	0%~24%	25%~49%	50%~74%	75%~100%
				

### Mode Operation Information

	Indicates unit connects to the mains.
	Indicates unit connects to the PV panel.
	Indicates load is supplied by utility power.
	Indicates the solar charger circuit is working.
	Indicates the DC/AC inverter circuit is working.

### Mute Operation

	Indicates unit alarm is disabled.
--	-----------------------------------



## LCD Setting

After pressing and holding "ENTER" button for 2 seconds, the unit will enter setting mode. Press "UP" or "DOWN" button to select setting programs. And then, press "ENTER" or "MENU" button to confirm the selection and exit.

### Setting Programs:

Program	Description	Selectable option
00	Exit setting mode	Escape [00] ESC
01	Output source priority selection	[0] SBU Solar energy provides power to the loads as first priority. If battery voltage has been higher than the setting point in program 21 for 5 minutes, the inverter will turn to battery mode, solar and battery will provide power to the load at the same time. When the battery voltage drops to the setting point in program 20, the inverter will turn to bypass mode, utility provides power to the load only, and the solar will charge the battery at the same time.
		[0] SOL Solar energy provides power to the loads as first priority. If battery voltage has been higher than the setting point in program 21 for 5 minutes, and the solar energy has been available for 5 minutes too, the inverter will turn to battery mode, solar and battery will provide power to the load at the same time. When the battery voltage drops to the setting point in program 20, the inverter will turn to bypass mode, utility provides power to the load only, and the solar will charge the battery at the same time.
		(default) [0] UT Utility will provide power to the loads as first priority. Solar and battery energy will provide power to the loads only when utility power is not available.
02	AC input voltage range	Appliances (default) [02] APL If selected, acceptable AC input voltage range will be within 90-280VAC.
		UPS [02] UPS If selected, acceptable AC input voltage range will be within 170-280VAC.
		GEN [02] GEN When the user uses the device to connect the generator, select the generator mode.

03	Output voltage	[03] 230 <sup>v</sup>	Set the output voltage amplitude, (220VAC-240VAC)		
04	Output frequency	50HZ(default) [04] 500 <sup>Hz</sup>	60HZ [04] 600 <sup>Hz</sup>		
05	Solar supply priorit	(default) [05] 6LU	Solar energy provides power to charge battery as first priority.		
		[05] L6U	Solar energy provides power to the loads as first priority.		
06	Overload bypass: When enabled, the unit will transfer to line mode if overload occurs in battery mode.	Bypass disable(default) [06] 6Yd	Bypass enable [06] 6YE		
07	Auto restart when overload occurs	Restart disable(default) [07] LTd	Restart enable [07] LTE		
08	Auto restart when over temperature occurs	Restart disable(default) [08] LTd	Restart enable [08] LTE		
10	Charger source priority: To configure charger source priority	If this inverter/charger is working in Line, Standby or Fault mode, charger source can be programmed as below:			
		Solar first [10] C50	Solar energy will charge battery as first priority. Utility will charge battery only when solar energy is not available.		
		Solar and Utility(default) [10] 5NU	Solar energy and utility will charge battery at the same time.		
		Only Solar [10] 050	Solar energy will be the only charger source no matter utility is available or not		
		If this inverter/charger is working in Battery mode, only solar energy can charge battery. Solar energy will charge battery if it's available and sufficient.			
11	Maximum charging current: To configure total charging current for solar and utility chargers.(Max. charging current =utility charging current + solar charging current)	80A (default) [11] 80 <sup>A</sup>	4KW 24V	1-160A	
			5KW 24V	1-180A	
			4KW 48V	1-140A	
			5KW 48V	1-150A	
			6KW 48V	1-160A	
			8KW 48V	1-200A	1-300A
			10KW 48V	1-220A	1-320A
			12KW 48V	1-240A	1-340A
13	Maximum utility charging current	30A (default) [13] 30 <sup>A</sup>	4KW 24V	1-80A	
			5KW 24V	1-100A	
			4KW 48V	1-60A	
			5KW 48V	1-70A	
			6KW 48V	1-80A	
			8KW 48V	1-100A	
			10KW 48V	1-120A	
			12KW 48V	1-140A	

14	Battery type	AGM (default) [14] AGM	Flooded [14] FLd
		GEL [14] GEL	LEAD [14] LEA
		Lithium Ion [14] L	User-Defined [14] USE
		If "User-Defined" LI is selected, battery charge voltage and low DC cut-off voltage can be set up in program 17, 18 and 19.	
17	Bulk charging voltage (C.V voltage)	24V model default setting: 28.2V [17] CV 28.2 <sup>v</sup>	
		If "User-Defined" LI is selected in program 14, this program can be set up. Setting range is from 24.0V to 29.2V for 24Vdc model. Increment of each click is 0.1V	
		48V model default setting: 56.4V [17] CV 56.4 <sup>v</sup>	
		If self-defined is selected in program 14, this program can be set up. Setting range is from 48.0V to 58.4V for 48Vdc model. Increment of each click is 0.1V.	
18	Floating charging voltage	24V model default setting: 27.0V [18] FLV 27.0 <sup>v</sup>	
		If "User-Defined" LI is selected in program 14, this program can be set up, Setting range is from 24.0V to 29.2V for 24Vdc model. Increment of each click is 0.1V	
		48V model default setting: 54.0V [18] FLV 54.0 <sup>v</sup>	
		If self-defined is selected in program 14, this program can be set up, Setting range is from 48.0V to 58.4V for 48Vdc model. Increment of each click is 0.1V.	
19	Low DC cut off battery voltage setting	24V model default setting: 20.4V [19] COV 20.4 <sup>v</sup>	
		If "User-Defined" LI is selected in program 14, this program can be set up. Setting range is from 20.0V to 24.0V for 24Vdc model. Increment of each click is 0.1V. Low DC cut-off voltage will be fixed to setting value no matter what percentage of load is connected.	
		48V model default setting: 40.8V [19] COV 40.8 <sup>v</sup>	
		If self-defined is selected in program 14, this program can be set up. Setting range is from 40.0V to 48.0V for 48Vdc model. Increment of each click is 0.1V. Low DC cut-off voltage will be fixed to setting value no matter what percentage of load is connected.	



















20	Battery stop discharging voltage when grid is available	Available options for 24V models:	
		23.0V (default) [20] 23.0 <sub>v</sub>	Setting range is from 22.0V to 29.0V. Increment of each click is 0.1V.
21	Battery stop charging voltage when grid is available	Available options for 48V models:	
		46.0V (default) [20] 46.0 <sub>v</sub>	Setting range is from 44.0V to 58.0V. Increment of each click is 0.1V.
22	Auto turn page	Available options for 24V models:	
		27.0V (default) [21] 27.0 <sub>v</sub>	Setting range is from 22.0V to 29.0V. Increment of each click is 0.1V.
23	Backlight control	Available options for 48V models:	
		54.0V (default) [21] 54.0 <sub>v</sub>	Setting range is from 44.0V to 58.0V. Increment of each click is 0.1V.
24	Alarm control	(default) [22] PLE	If selected, the display screen will auto turn the display page.
		[22] Pld	If selected, the display screen will stay at latest screen user finally switches.
25	Beeps while primary source is interrupted	Backlight on [23] LON	Backlight off (default) [23] LOF
		Alarm on (default) [24] BON	Alarm off [24] BOF
27	Record Fault code	Alarm on [25] AON	Alarm off (default) [25] AOF
		Record enable(default) [27] FON	Record disable [27] FOF
28	Solar power balance: When enabled, solar input power will be automatically adjusted according to connected load power.	Solar power balance enable [28] 56E	If selected, the solar input power will be automatically adjusted according to the following formula: Max. Input solar power = Max.battery charging power + Connected load power when the machine in OffGrid workstate.
		Solar power balance disable (default) [28] 56d	If selected, the solar input power will be the same to max. Battery charging power no matter how much loads are connected. The max.battery charging power will be based on the setting current in program 11 ( Max. solar power = Max.battery charging power )













30	Battery equalization	Battery equalization [30]EEN	Battery equalization disable(default) [30]EdS
31	Battery equalization voltage	Available options for 24V models:28.8V [31]E <sup>V</sup> 288 <sup>V</sup>	
		Available options for 48V models:57.6V [31]E <sup>V</sup> 576 <sup>V</sup>	
		Setting range is from 24.0V to 29.2V for 24V model and 48.0V to 58.4V for 48V model. Increment of each click is 0.1V.	
33	Battery equalization time	60min(default) [33] 60	Setting range is from 5 min to 900min. Increment of each click is 5min.
34	Battery equalization timeout	120min(default) [34] 120	Setting range is from 5 min to 900min. Increment of each click is 5min.
35	Equalization interval	30days(default) [35] 30d	Setting range is from 0 to 90days. Increment of each click is 1 day.
36	Equalization activated immediately	Enable [36]AEN	Disable(default) [36]AdS
		If equalization function is enabled in program 30, this program can be set up. If "Enable" is selected in this program, it's to activate battery equalization immediately and LCD main page will show "EQ". If "Disable" is selected, it will cancel equalization function until next activated equalization time arrives based on program 35 setting. At this time, "EQ" will be shown in LCD main page too.	

After pressing and holding "MENU" button for 6 seconds, the unit will enter reset model. Press "UP" and "DOWN" button to select programs. And then, press "ENTER" button to exit.













SET	(default) [dt] nft	Reset setting disable
	[dt] tSt	Reset setting enable

## Fault Reference Code

Fault Code	Fault Cause	LCD Indication
01	Fan is locked when inverter is off	
02	Inverter transformer over temperature	
03	Battery voltage is too high	
04	Battery voltage is too low	
05	Output short circuited	
06	Inverter output voltage is high	
07	Overload time out	
08	Inverter bus voltage is too high	
09	Bus soft start failed	
11	Main relay failed	
21	Inverter output voltage sensor error	
22	Inverter grid voltage sensor error	
23	Inverter output current sensor error	
24	Inverter grid current sensor error	
25	Inverter load current sensor error	
26	Inverter grid over current error	
27	Inverter radiator over temperature	
31	Solar charger battery voltage class error	
32	Solar charger current sensor error	



33	Solar charger current is uncontrollable	[33] 
41	Inverter grid voltage is low	[41] 
42	Inverter grid voltage is high	[42] 
43	Inverter grid under frequency	[43] 
44	Inverter grid over frequency	[44] 
51	Inverter over current protection error	[51] 
52	Inverter bus voltage is too low	[52] 
53	Inverter soft start failed	[53] 
55	Over DC voltage in AC output	[55] 
56	Battery connection is open	[56] 
57	Inverter control current sensor error	[57] 
58	Inverter output voltage is too low	[58] 

## Warning Indicator

Warning Code	Warning Event	Icon flashing
61	Fan is locked when inverter is on.	[61] 
62	Fan 2 is locked when inverter is on.	[62] 
63	Battery is over-charged.	[63] 
64	Low battery	[64] 
67	Overload	[67]  
70	Output power derating	[70] 
72	Solar charger stops due to low battery	[72] 
73	Solar charger stops due to high PV voltage	[73] 
74	Solar charger stops due to over load	[74] 
75	Solar charger over temperature	[75] 
76	PV charger communication error	[76] 
77	Parameter error	[77] 

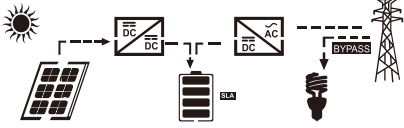
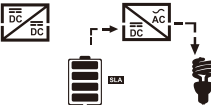
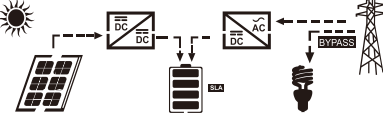
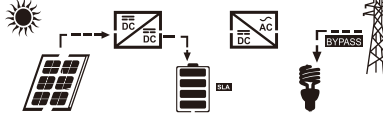
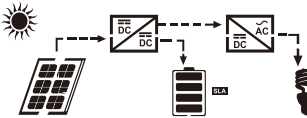
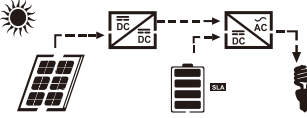
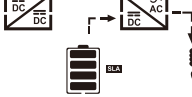

## Operating State Description

Operation state	Description	LCD display
Utility-Tie state	PV energy is charger into the battery and utility provide power to the AC load.	PV is on 
		PV is off 
Charge state	PV energy and grid can charge batteries.	
Bypass state	Error are caused by inside circuit error or external reasons such as over temperature, output short circuited and so on.	
Off-Grid state	The inverter will provide output power from battery and PV power.	Inverter power loads from PV energy 
		Inverter power loads from battery and PV energy 
		Inverter power loads from battery only 
Stop state	The inverter stop working if you turn off the inverter by the soft key or error has occurred in the condition of no grid.	

## Display Setting

The LCD display information will be switched in turns by pressing "UP" or "DOWN" key. The selectable information is switched as below order: battery voltage, battery current, inverter voltage, inverter current, grid voltage, grid current, load in Watt, load in VA, grid frequency, inverter frequency, PV voltage, PV charging power, PV charging output voltage, PV charging current.

Selectable information	LCD display	
Battery voltage/DC discharging current	260 <sup>BATT</sup> <sub>V</sub>	480 <sup>A</sup>
Inverter output voltage/Inverter output current	229 <sub>V</sub>	67 <sup>INV</sup> <sub>A</sub>
Grid voltage/Grid frequency	229 <sub>V</sub>	500 <sub>Hz</sub>
Load in Watt/VA	150 <sup>KW</sup>	168 <sup>LOAD</sup> <sub>VA</sub>
Grid frequency/Inverter frequency	500 <sup>INPUT</sup> <sub>Hz</sub>	500 <sup>INV</sup> <sub>Hz</sub>
PV voltage and power	610 <sup>PV</sup> <sub>V</sub>	100 <sup>KW</sup>
PV charger output voltage and PV charging current	250 <sup>PV</sup> <sub>V</sub>	400 <sup>OUTPUT</sup> <sub>A</sub>

## SPECIFICATIONS

Table 1 Line Mode Specifications

INVERTER MODEL	4KW 24V	5KW 24V	4KW 48V	5KW 48V	6KW 48V	8KW 48V	10KW 48V	12KW 48V
<b>Input Voltage Waveform</b>	Sinusoidal (utility or generator)							
<b>Nominal Input Voltage</b>	230Vac							
<b>Low Loss Voltage</b>	90Vac±7V(APL,GEN);170Vac±7V(UPS); 186Vac±7V(VDE)							
<b>Low Loss Return Voltage</b>	100Vac±7V(APL,GEN);180Vac±7V(UPS); 196Vac±7V(VDE)							
<b>High Loss Voltage</b>	280Vac±7V(UPS,APL,GEN); 253Vac±7V(VDE)							
<b>High Loss Return Voltage</b>	270Vac±7V(UPS,APL,GEN); 250Vac±7V(VDE)							
<b>Max AC Input Voltage</b>	300Vac							
<b>Nominal Input Frequency</b>	50HZ/60HZ(Auto detection)							
<b>Low Loss Frequency</b>	40HZ±1HZ(UPS,APL,GEN); 47.5HZ±0.05HZ(VDE)							
<b>Low Loss Return Frequency</b>	42HZ±1HZ(UPS,APL,GEN); 47.5HZ±0.05HZ(VDE)							
<b>High Loss Frequency</b>	65HZ±1HZ(UPS,APL,GEN); 51.5HZ±0.05HZ(VDE)							
<b>High Loss Return Frequency</b>	63HZ±1HZ(APL,GEN,UPS); 50.05HZ±0.05HZ(VDE)							

<b>Output Short Circuit Protection</b>	Line mode: Circuit Breaker Battery mode: Electronic Circuits
<b>Efficiency (Line Mode)</b>	>95%(Rated R load, battery full charged)
<b>Transfer Time</b>	10ms typical (UPS,VDE) 20ms typical (APL)
<b>Output power derating:</b> When AC input voltage drops to 95V or 170V depending on models, the output power will be derated.	230Vac model:  <p>The graph illustrates the output power derating characteristics for a 230Vac model. The vertical axis represents Output Power, and the horizontal axis represents AC Input Voltage. At 90V, the output power is 0%. As the input voltage increases, the output power rises linearly, reaching the Rated Power at 170V. From 170V to 250V, the output power remains constant at the Rated Power level. Beyond 250V, the output power drops to 0%. A specific point is marked at 25% Power, which occurs at an input voltage between 90V and 170V.</p>

Table 2 Inverter Mode Specifications

<b>INVERTER MODEL</b>	4KW 24V	5KW 24V	4KW 48V	5KW 48V	6KW 48V	8KW 48V	10KW 48V	12KW 48V
<b>Rated Output Power</b>	4KW	5KW	4KW	5KW	6KW	8KW	10KW	12KW
<b>Output Voltage Waveform</b>	Pure Sine Wave							
<b>Output Voltage Regulation</b>	230Vac±5%							
<b>Output Frequency</b>	60Hz or 50Hz							
<b>Peak Efficiency</b>	>83%		>85%				>88%	
<b>Overload Protection</b>	5min@100%~110% load; 10s@110%~125% load;5s@>125% load							
<b>Surge Capacity</b>	2* rated power for 500 millisecond							
<b>Nominal DC Input Voltage</b>	24Vdc		48Vdc					
<b>Cold Start Voltage</b>	23.0Vdc		46.0Vdc					
<b>Low DC Warning Voltage</b>								
@ load < 20%	22.0Vdc		44.0Vdc					
@ 20% ≤ load < 50%	21.4Vdc		42.8Vdc					
@ load ≥ 50%	20.2Vdc		40.4Vdc					
<b>Low DC Warning Return Voltage</b>								
@ load < 20%	23.0Vdc		46.0Vdc					
@ 20% ≤ load < 50%	22.4Vdc		44.8Vdc					
@ load ≥ 50%	21.2Vdc		42.4Vdc					

<b>Low DC Cut-off Voltage</b>								
@ load < 20%	21.0Vdc		42.0Vdc					
@ 20% ≤ load < 50%	20.4Vdc		40.8Vdc					
@ load ≥ 50%	19.2Vdc		38.4Vdc					
<b>High DC Recovery Voltage</b>	29Vdc		58Vdc					
<b>High DC Cut-off Voltage</b>	30Vdc		60Vdc					
<b>No Load Power Consumption</b>	100W	120W	100W	120W	150W	180W	190W	200W
<b>No Load Power Consumption (Power Saver Auto)</b>	6W		6.6W			8.6W		
<b>Power Saver Auto</b>	25W							

Table 3 Charge Mode Specifications

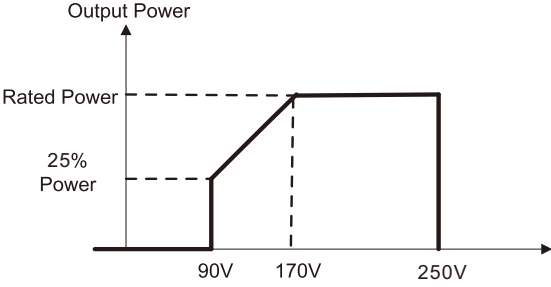
<b>Utility Charging Mode</b>									
<b>INVERTER MODEL</b>		4KW 24V	5KW 24V	4KW 48V	5KW 48V	6KW 48V	8KW 48V	10KW 48V	12KW 48V
<b>Charging Current @ Nominal Input Voltage</b>		1~80A	1~100A	1~60A	1~70A	1~80A	1~100A	1~120A	1~140A
<b>Absorption Voltage</b>	<b>AGM / Gel/LEAD Battery</b>	25Vdc		50Vdc					
	<b>Flooded battery</b>	25Vdc		50Vdc					
<b>Refloat Voltage</b>	<b>AGM / Gel/LEAD Battery</b>	27.4Vdc		54.8Vdc					
	<b>Flooded battery</b>	27.4Vdc		54.8Vdc					
<b>Float Voltage</b>	<b>AGM / Gel/LEAD Battery</b>	28.8Vdc		57.6Vdc					
	<b>Flooded battery</b>	28.4Vdc		56.8Vdc					
<b>Charging Algorithm</b>		3-Step(Flooded Battery, AGM/Gel/LEAD Battery), 4-Step(LI)							
<b>Solar Charging Mode</b>									
<b>INVERTER MODEL</b>		4KW 24V	5KW 24V	4KW 48V	5KW 48V	6KW 48V	8KW 48V	10KW 48V	12KW 48V
<b>Charging Current (MPPT)</b>		80AMP					100A/200A		
<b>System DC Voltage</b>		24Vdc		48Vdc					
<b>Operating Voltage Range</b>		30~130Vdc		60~130Vdc					
<b>Max.PV Array Open Circuit Voltage</b>		145Vdc max							
<b>Standby Power Consumption</b>		2W							
<b>Battery Voltage Accuracy</b>		+/-0.4%							
<b>PV Voltage Accuracy</b>		+/-2V							
<b>Charging Algorithm</b>		3-Step(Flooded Battery, AGM/Gel/LEAD Battery), 4-Step(LI)							

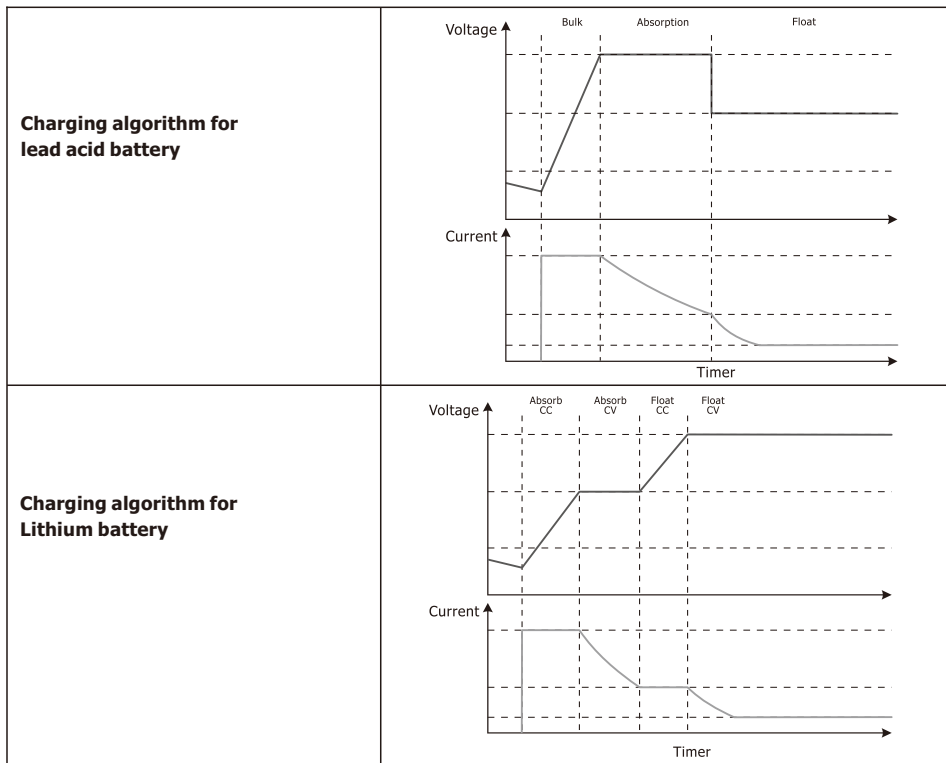

Table 4 General Specifications

<b>INVERTER MODEL</b>	4KW 24V	5KW 24V	4KW 48V	5KW 48V	6KW 48V	8KW 48V	10KW 48V	12KW 48V
<b>Safety Certification</b>	CE							
<b>Operating Temperature Range</b>	0°C to 40°C							
<b>Storage temperature</b>	-25°C~ 60°C							
<b>Dimension (D*W*H), mm</b>								
<b>Net Weight, kg</b>								

## TROUBLE SHOOTING

Problem	LCD/LED/Buzzer	Explanation / Possible cause	What to do
Unit shuts down automatically during startup process.	LCD/LEDs and buzzer will be active for 3 seconds and then complete off.	The battery voltage is too low (< 1.91V/Cell)	1. Re-charge battery. 2. Replace battery.
No response after power on.	No indication.	1. The battery voltage is far too low. (<1.4V/Cell) 2. Battery polarity is connected reversed. Input protector is tripped	1. Check if batteries the wiring are connected and well. 2. Re-charge battery. 3. Replace battery.
Mains exist but the unit works in battery mode.	Input voltage is displayed as 0 on the LCD and green LED is flashing.	Input protector is tripped	Check if AC breaker is tripped and AC wiring is connected well.
	Green LED is flashing.	Insufficient quality of AC power (Shore or Generator)	1. Check if AC wires are too thin and/or too long. 2. Check if generator (if applied) is working well or if input voltage range setting is correct. (Appliance=>wide)
When the unit is turned on, internal relay is switched on and off repeatedly.	LCD display and LEDs are flashing	Battery is disconnected.	Check if battery wires are connected well.
Buzzer beeps continuously and red LED is on.	Fault code 07	Overload error. The inverter is overload 110% and time is up.	Reduce the connected load by switching off some equipment.
	Fault code 05	Output short circuited.	Check if wiring is connected well and remove abnormal load.
	Fault code 02	Internal temperature of inverter component is over 90°C.	Check whether the air flow of the unit is blocked or whether the ambient temperature is too high.
	Fault code 03	Battery is over-charged.	Return to repair center.
		The battery voltage is too high.	Check if spec and quantity of batteries are meet requirements.
	Fault code 01	Fan fault	Fan fault
	Fault code 06/58	Output abnormal (Inverter voltage below than 202Vac or is higher than 253Vac)	1. Reduce the connected load. 2. Return to repair center
	Fault code 08/09/53/57	Internal components filed.	Return to repair centre
	Fault code 51	Over current or surge	Restart the unit, if the error happens again, please return to repair center.
	Fault code 52	Bus voltage is too low	
Fault code 55	Output voltage is unbalanced		
Fault code 56	Battery is not connected well or fuse is burnt.	If the battery is connected well, please return to repair center.	



# USER'S MANUAL

## SOLAR INVERTER

Please download the software "SolarPowerMonitor2.2.81".



China:<https://cn.must-ee.com>



Oversea:<https://en.must-ee.com>